

Baby Titan I

High-Power LED SpotLight



Features

- Vandal-proof polycarbonate face
- Powered by Luxeon Rebel™
- Weatherproof to IP68
- 700mA maximum drive current
- Durable machined aluminium housing
- Integral adjustable bracket

Description

The Baby Titan I is a high-powered single-colour spotlight which uses 6 high-power Luxeon Rebel LEDs.

The unit is IP68 rated and is at home in any indoor or outdoor venue.

The fully adjustable and lockable bracket ensures easy mounting on most surfaces.

An optional ground spike is available for installations in soft ground.

Available in various colour combinations the Baby Titan I can create any mood or effect that you desire.

LIGHTING PERFORMANCE

Model	Light Source	LED Qty	Lumen Output	Expected Lifetime
Single-Colour	Luxeon Rebel	6	480 @ 350mA	50,000hrs +
Single-Colour	Luxeon Rebel	6	864 @ 700mA	50,000hrs +

NB: Lumen values quoted on Cool White (6500°K)

INPUT DATA

Model	Drive Current	Input Voltage	Power Supply	Input Connection
Single-Colour	350mA-700mA	N/A	Constant Current	Flying Lead (2M)

OPERATING DETAILS

Model	Input Power	Ambient Temp. Range
Single-Colour	7.2W @ 350mA / 14.4W @ 700mA	-10 to +40 Degrees C

PHYSICAL DETAILS

Model	Mounting Type	Finish	Ingress Protection
Single-Colour	Aluminium rotating bracket	Matt Silver Anodised	IP68 @ 1 Bar

OPTIONS

Model	Optics
Single-Colour	6, 15, 25, 40 degrees (half-divergence angle)

COLOURS

Model	Single LED Colours
Single-Colour	Red, Green, Blue, Amber, Cool White, Neutral White, Warm White

RECOMMENDED DRIVERS

Model
D10CC350-1-7IP67
D18CC350-4-14IP67
D18CC700-3-6IP67
D36CC700-4-14IP67

PROFILE DIMENSIONS

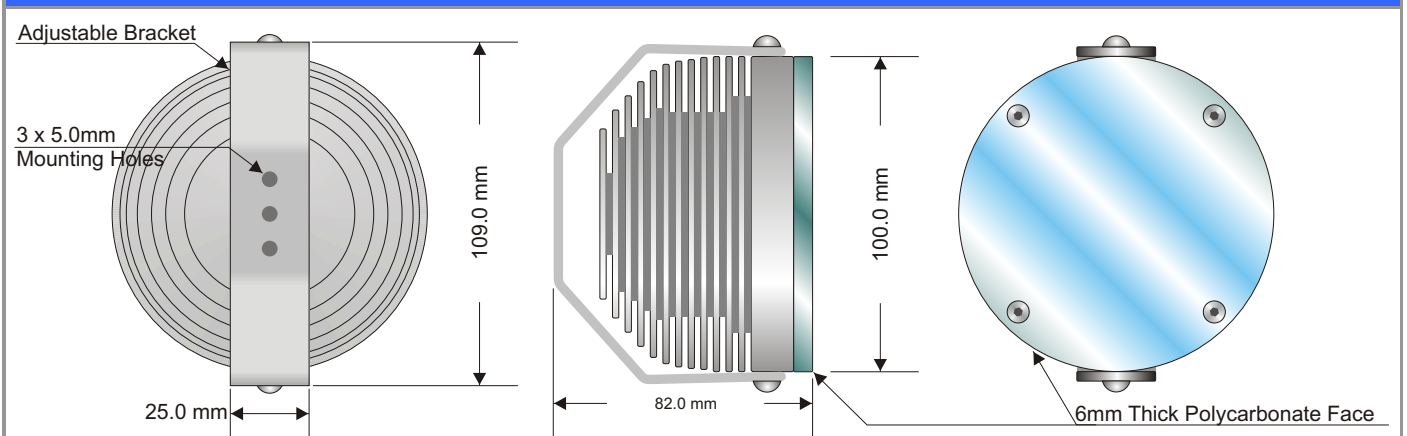

We reserve the right to make changes at any time in order to maintain the highest product quality.